

TEST SPECIFICATIONS

1. TEMPERATURE/ROTATIONAL SPEED CURVE

The newly developed LX seal reduces the generation of heat.

Test conditions:

Bearing designation: BSTU3080LLX/GNP4U/L588

Rotational speed: up to 5,000 min⁻¹

Lubricant: Special grease L588

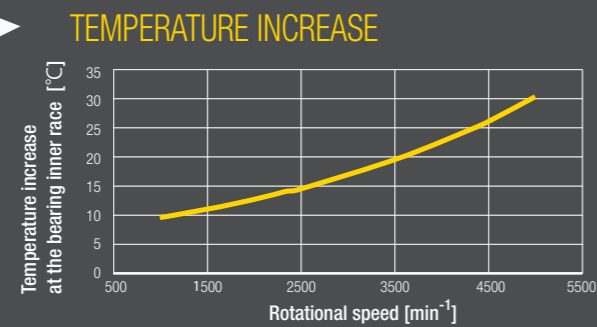

2. TORQUE

The LX seal has only a minimal influence on the breakout torque of the bearing.

Test conditions:

Bearing designation: BSTU3080LLX/GNP4U/L588

Lubricant: Special grease L588

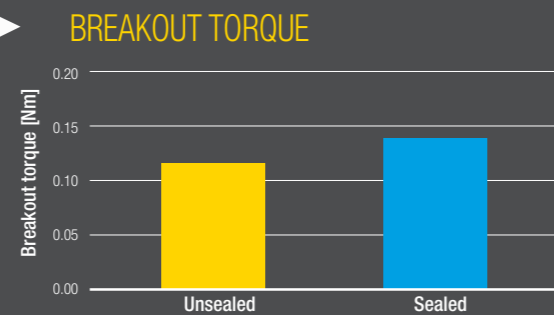

3. BEARING RIGIDITY

BSTU bearings offer a very high rigidity, thanks to the use of a maximum number of large-diameter balls.

Test conditions:

Bearing designation: BSTU3080LLX/GNP4U/L588

Axial thrust load: up to 20 kN

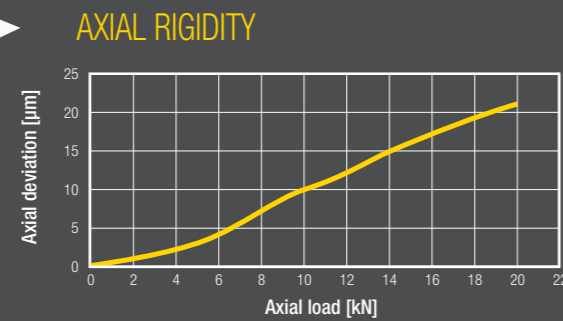

4. GREASE

The BSTU bearings are filled with special long-life polyurea-based grease (L588).

This grease is very effective in reducing standstill wear and fretting corrosion of the bearing. Ball/plate tests proved the wear-reducing properties of the grease.

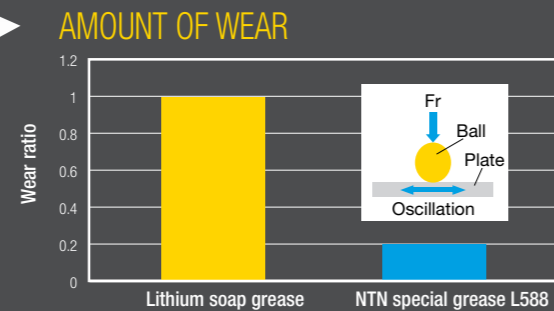

5. SEAL

A spindle ball bearing is constantly subjected to cooling liquids and metal shavings. After the test, no contamination was detected on the inside of the BSTU bearing.

Test conditions:

Bearing designation: BSTU3080LLX/GNP4U/L588

Rotational speed: up to 2,200 min⁻¹

Lubricant: Special grease L588

Dirt particles: Diameter: 5 to 75 µm

Components: SiO₂, Fe₂O₃, Al₂O₃ and others

Color of dirt particles: Brown

Test duration: 1 hour

BALL SCREW SUPPORT BEARING UNIT



Distributed by:

BALL SCREW SUPPORT BEARING UNIT
BSTU



With You



The BSTU series produced by NTN are characterized by the highest basic load rating, which ensures a long service life. In this way, NTN contributes to the protection of the environment. In addition, BSTU bearings are very simple to install.

- Long service life and rigidity
- High precision
- Low temperature development
- Low frictional torque

Technical characteristics **ULTAGE**

1. HIGHEST BASIC LOAD RATING

BSTU bearings by NTN feature the highest basic load rating available. NTN achieved this by optimising the inner bearing geometry. In addition to a larger ball diameter, BSTU bearings are equipped with a larger quantity of balls.

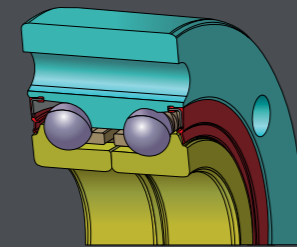

2. LIGHT CONTACT-TYPE SEAL

- Optimum sealing effect
- Lowest frictional torque

The sealing lip of the LX seal represents the optimum solution in regard to sealing effect and frictional torque. BSTU bearings by NTN are equipped with these seals on both sides of the bearing.

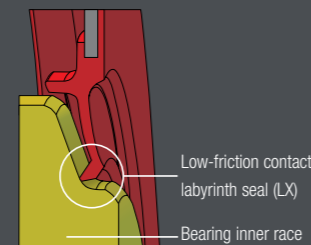

3. APPLICATION-OPTIMISED GREASE

A special polyurea-based, long-life grease reduces standstill and vibration rubbing wear (fretting corrosion).

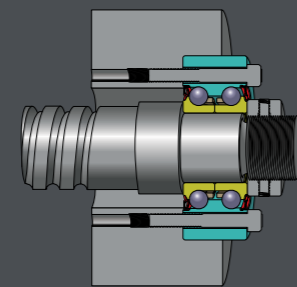

4. SIMPLE MOUNTING PROCESS

BSTU bearings can be simply bolted to the housing, thanks to the pre-drilled through holes.

As an option, BSTU bearings are available with service lubrication openings and a groove in the outer race. BSTU bearings are also available as paired sets (suffix: D2).

BSTU designation

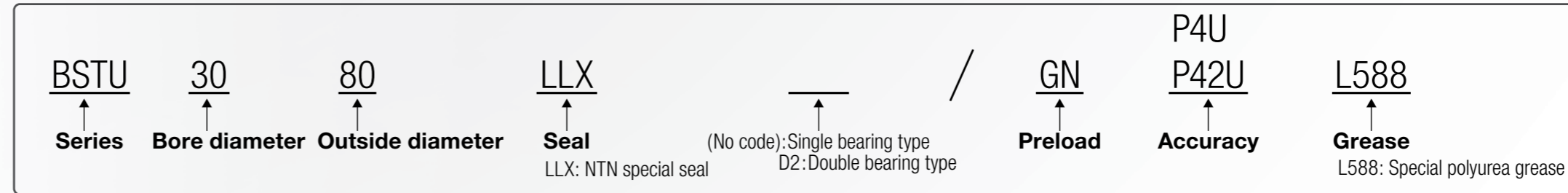

BSTU Table⁽¹⁾

Bearing dimensions

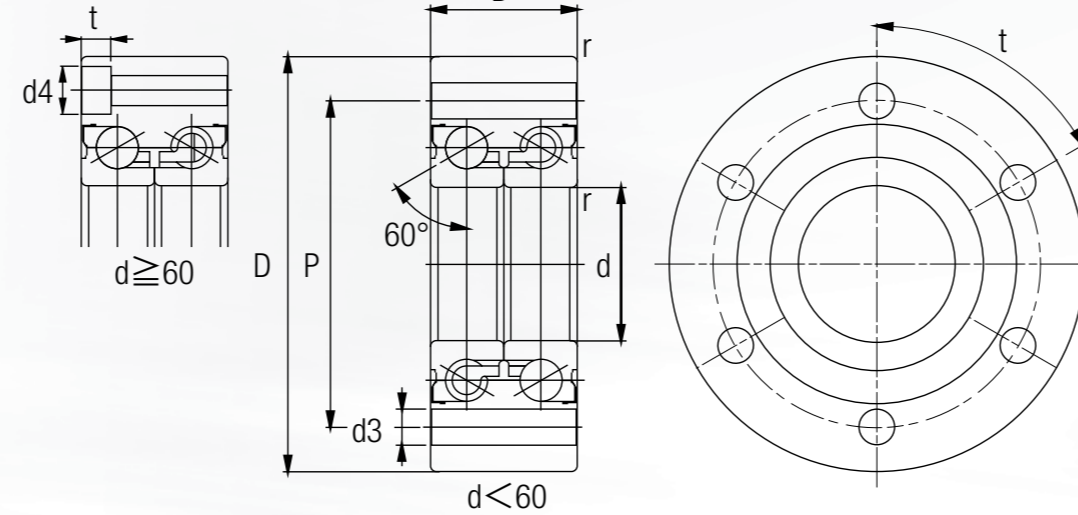

Mounting dimensions

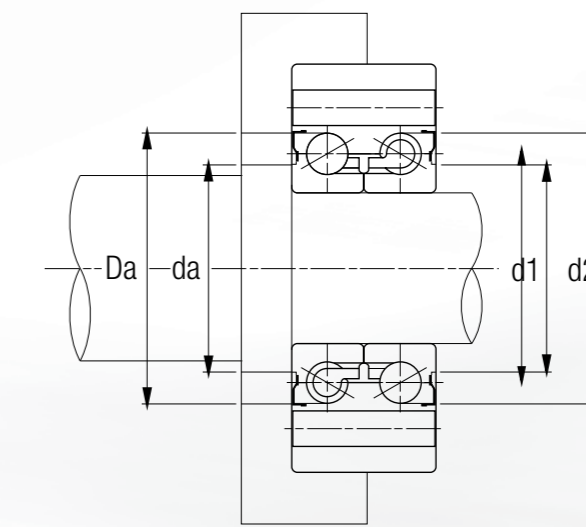

Fitting of modification parts

Shaft	Housing
h5	H6

Dynamically equivalent load

$$P_a = XFr + YFa$$

e	Fa/Fr ≤ e		Fa/Fr > e	
	X	Y	X	Y
2.17	1.90	0.55	0.92	1

Statically equivalent load

$$P_{or} = Fa + 3.98Fr$$

Bearing designation	Dimensions (mm)									Mounting dimensions (mm)		Screws and attachment holes	Axial basic load rating values (kN)		Bearing preload (GN)	Limit value of rotational speed (Grease)	Weight	Bearing friction moment (1)	Axial bearing rigidity	Rigidity against tilting	Mass moment of inertia (2)	Axial runout of the inner race lateral surface in relation to the inner race track, Sia	
	d	D	B	d1	d2	r min.	P	d3	Da max.	da min.	Screws (5)		Quantity X t	dyn. Ca								stat. Coa	N
BSTU2068	Ø20 ⁰ _{-0.005}	Ø68 ⁰ _{-0.01}	28 ⁰ _{-0.25}	30.1	43	0.6	53	6.8	42	26	M6	4X90° ("D2": 8x45°)	31	48	2100	6000	0.6	0.2	675	150	0.25	4	2
BSTU2575	Ø25 ⁰ _{-0.005}	Ø75 ⁰ _{-0.01}	28 ⁰ _{-0.25}	36.1	49	0.6	58	6.8	48	32	M6	4X90° ("D2": 8x45°)	34	58	2400	5000	0.72	0.3	790	230	0.45	4	2
BSTU3080	Ø30 ⁰ _{-0.005}	Ø80 ⁰ _{-0.01}	28 ⁰ _{-0.25}	41.1	54	0.6	63	6.8	53	37	M6	6X60° ("D2": 12x30°)	36.5	68.5	2700	4500	0.78	0.3	900	315	0.68	4	2.5
BSTU30100	Ø30 ⁰ _{-0.005}	Ø100 ⁰ _{-0.01}	38 ⁰ _{-0.25}	47.1	65	0.6	80	8.8	64	39	M8	8X45° ⁽³⁾	73.5	121	4800	4000	1.71	0.8	1040	495	1.99	4	2.5
BSTU40100	Ø40 ⁰ _{-0.005}	Ø100 ⁰ _{-0.01}	34 ⁰ _{-0.25}	54.1	68.9	0.6	80	8.8	68	49	M8	4X90° ("D2": 8x45°)	52	106	3200	3500	1.46	0.4	1050	780	2.16	4	2.5
BSTU40115	Ø40 ⁰ _{-0.005}	Ø115 ⁰ _{-0.01}	46 ⁰ _{-0.25}	61.1	80.2	0.6	94	8.8	80	52	M8	12X30° ("D2": 12x30°)	89	167	5800	3200	2.57	1.1	1250	1190	5.52	4	2.5
BSTU50115	Ø50 ⁰ _{-0.005}	Ø115 ⁰ _{-0.01}	34 ⁰ _{-0.25}	68.1	82.9	0.6	94	8.8	82	62	M8	6X60° ("D2": 12x30°)	57	135	3800	2800	1.87	0.5	1300	1080	5.06	4	2.5
BSTU90190	Ø90 ⁰ _{-0.008}	Ø190 ⁰ _{-0.015}	55 ⁰ _{-0.25}	116	139	0.6	165	11	137	104	M10	8X45° (d4=18, t=10.6) ⁽³⁾⁽⁴⁾	158	415	8200	1700	7.95	1.5	2010	4600	60.0	5	3
BSTU100200	Ø100 ⁰ _{-0.008}	Ø200 ⁰ _{-0.015}	55 ⁰ _{-0.25}	128	151	0.6	175	11	150	116	M10	8X45° (d4=18, t=10.6) ⁽³⁾⁽⁴⁾	160	435	8800	1500	8.47	1.7	2130	5800	83.8	5	3

(1) Reference value. (2) Mass moment of inertia of the inner race. (3) For these installation sizes there are no paired versions (D2) available. (4) Attachment holes have counter bores based on DIN 974-1. (5) Screws are based on DIN EN ISO 4762 10.9. Please note screws are not included in the packages of bearings.

As an option, BSTU bearings are available with service lubrication openings and a groove in the outer race. BSTU bearings are also available as paired sets (suffix: D2).